

EV West - DNR Switch Drive Switch Schematic For T2C

Revision 1.1 - 5/24

Pin #	Color	Function
1	Black	Signal Input
2	White	D Signal Output
3	Purple	R 12V+ Output
4	Brown	12V+ Input
5	Pink	12V- Input (Ground)
6	Yellow	R Signal Output
7	Red	D 12V+ Output

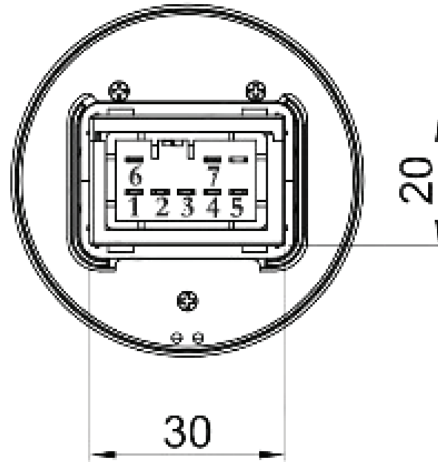

All dimensions are in millimeters

